

<b>NORLEG</b>	
Sammenbygget system	
LE 20937	
30.06.2015	REV. -

< 2450

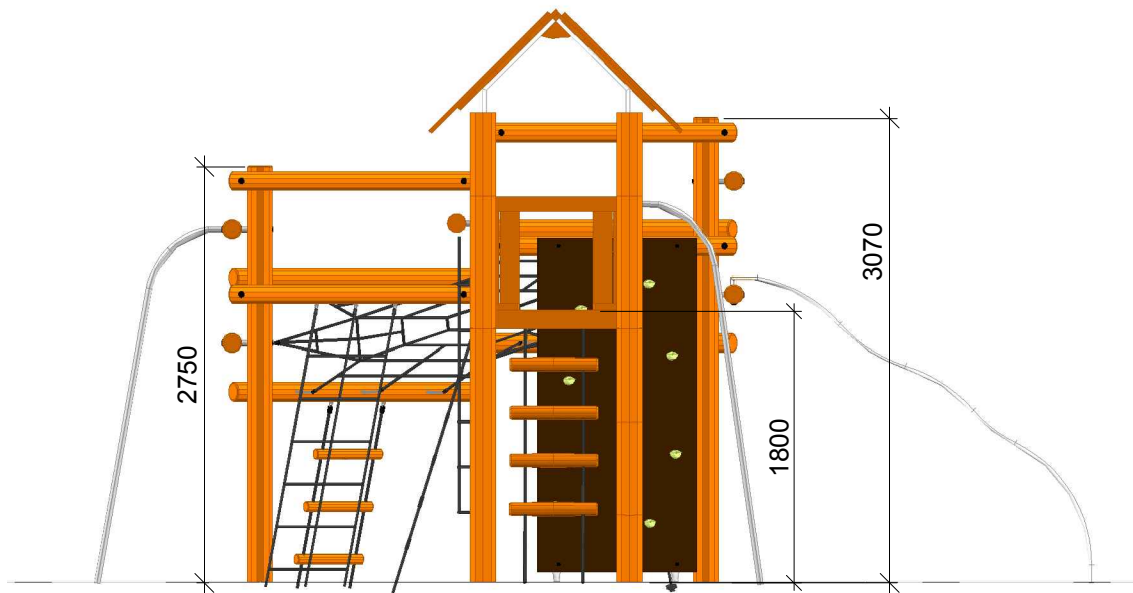

≥ EN 1176



1:50

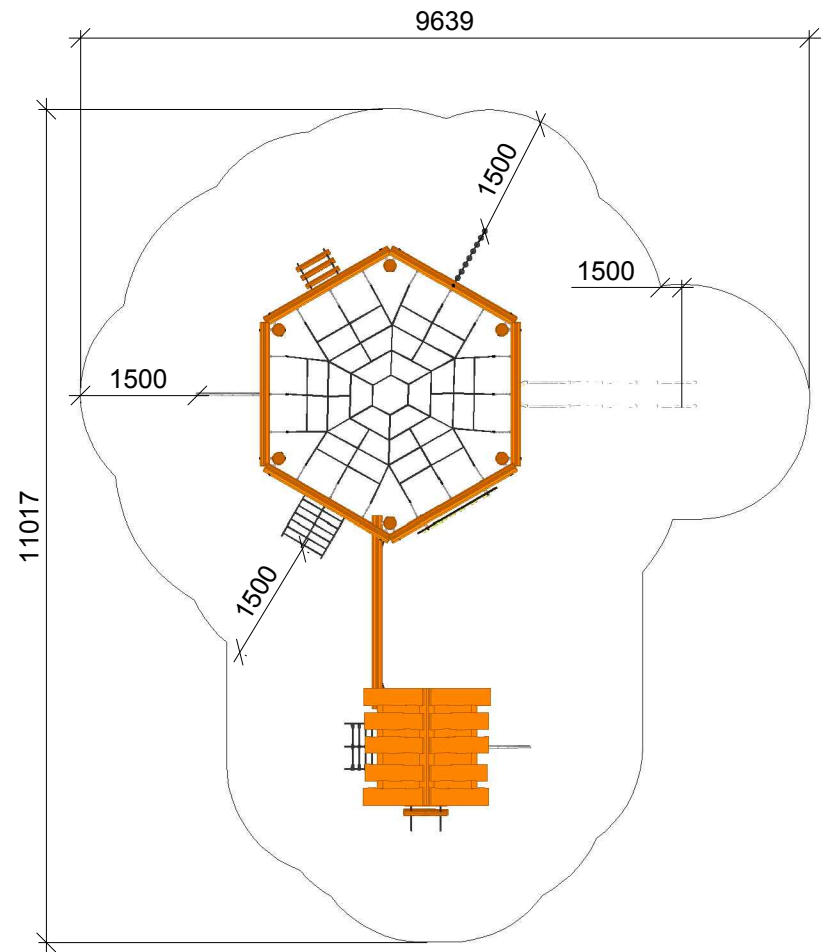

1:100

<b>NORLEG</b>	
Sammenbygget system	
LE 20937	
30.06.2015	REV. -

< 2450



≥ EN 1176

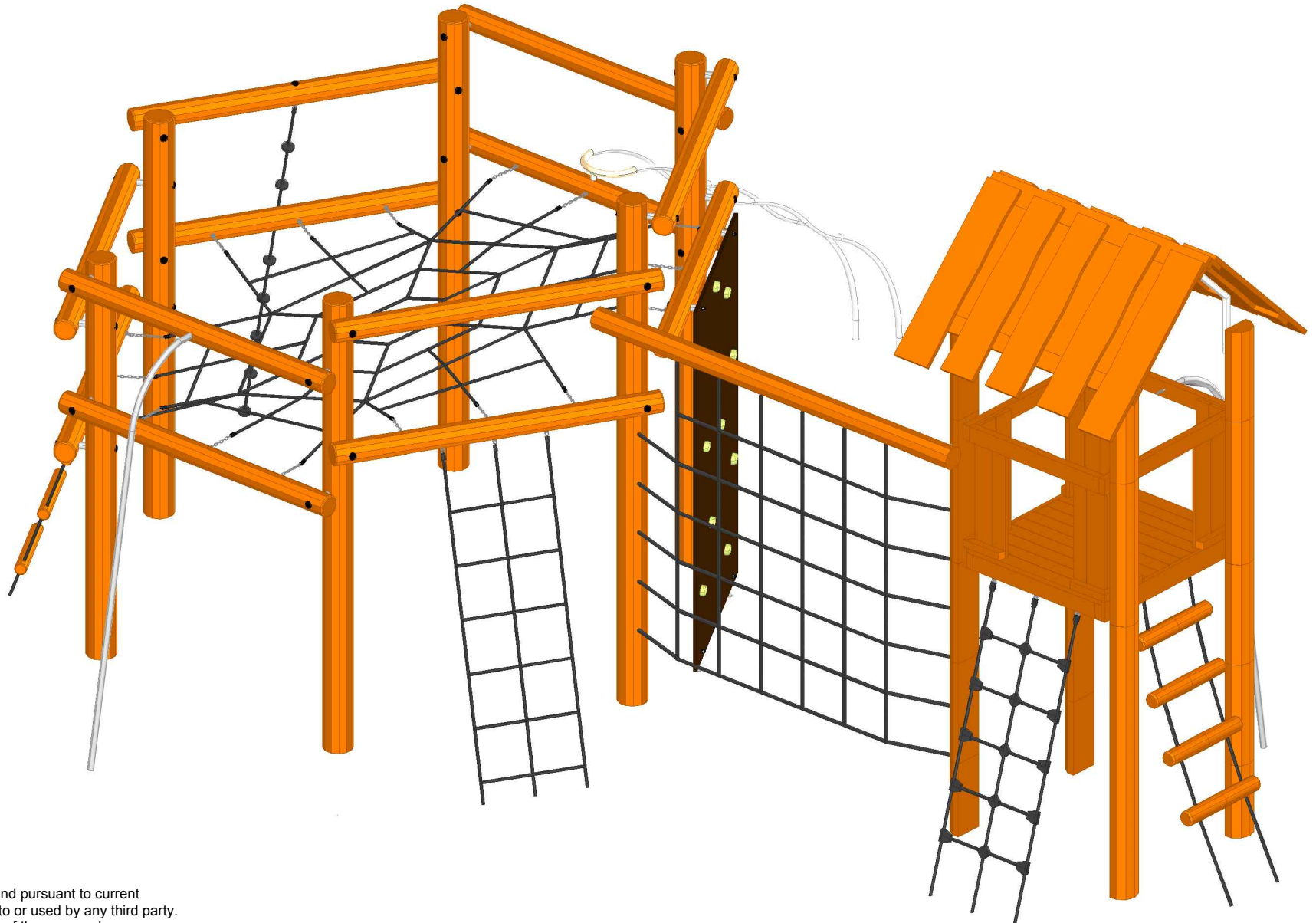

This drawing is the property of NORLEG and pursuant to current legislation may not be copied, transferred to or used by any third party. Should this drawing be used, a fee of 10% of the assumed contract price will be charged.

<b>NORLEG</b>	
<b>Sammenbygget system</b>	
LE 20937	
30.06.2015	REV. -

< 2450



≥ EN 1176



This drawing is the property of NORLEG and pursuant to current legislation may not be copied, transferred to or used by any third party. Should this drawing be used, a fee of 10% of the assumed contract price will be charged.

<b>NORLEG - Mont.</b>	
<b>Sammenbygget system</b>	
LE 20937	
30.06.2015	REV. -

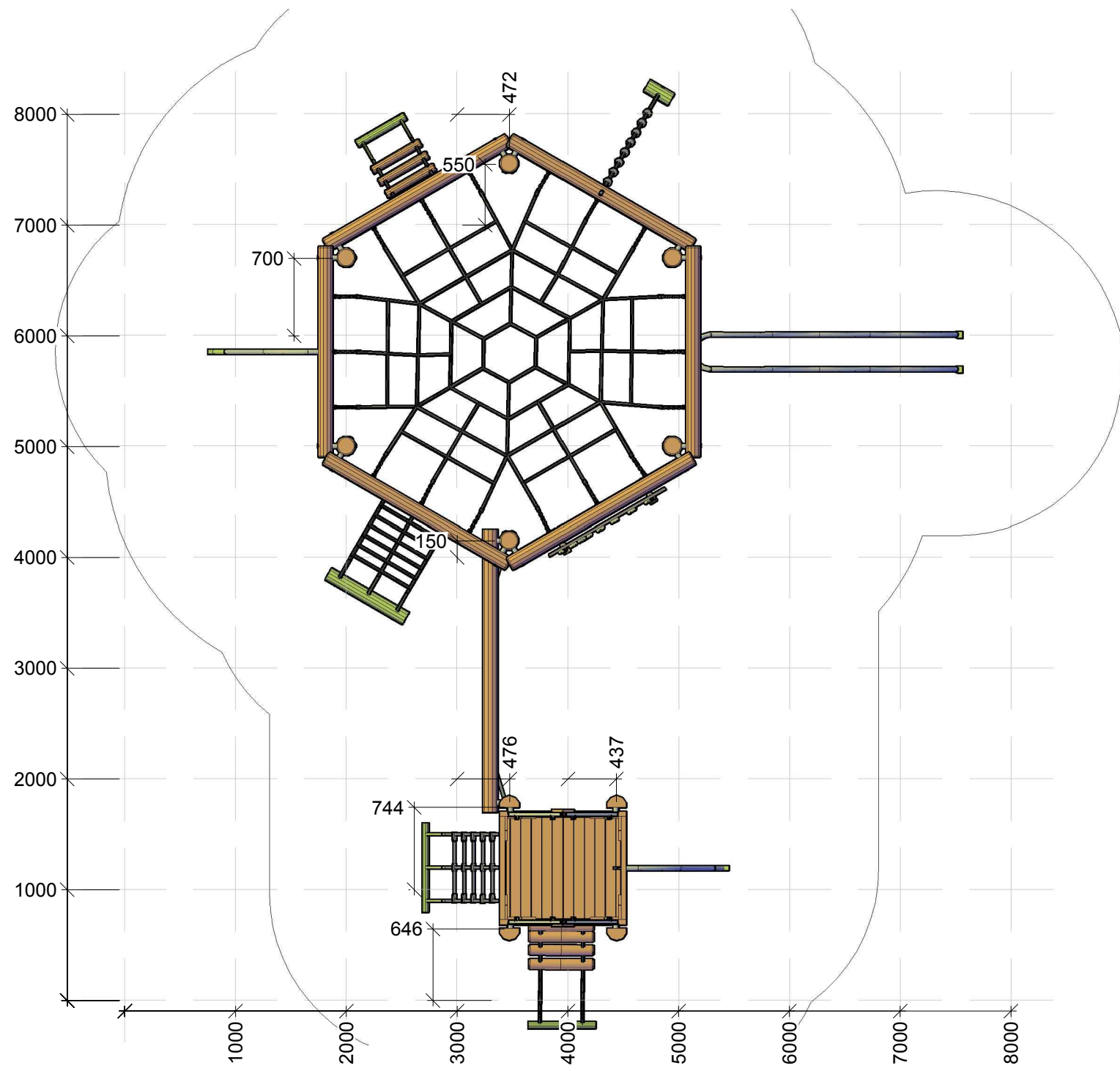
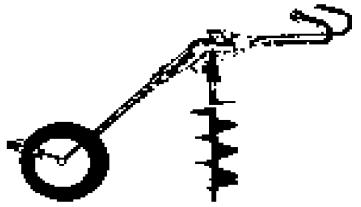

gældende lov ikke kopieres, overlades eller udnyttes af 3. mand. Sker dette, skal det påregnes, at der vil blive opkrævet et honorar på 10% af formodet entreprisesum.

<b>NORLEG</b> - Mont.	
<b>Sammenbygget system</b>	
LE 20937	
30.06.2015	REV. -

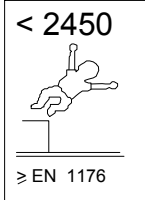

Parts list		
Mrk.	QTY	Part.no
P1	1	LE 20350
P2	2	LE 20371
P3	2	LE 20362
P4	1	LE 26037
P5	1	LE 20365
P6	1	LE 20387
P7	1	LE 20373
P8	1	LE 20366
P9	1	LE 26021

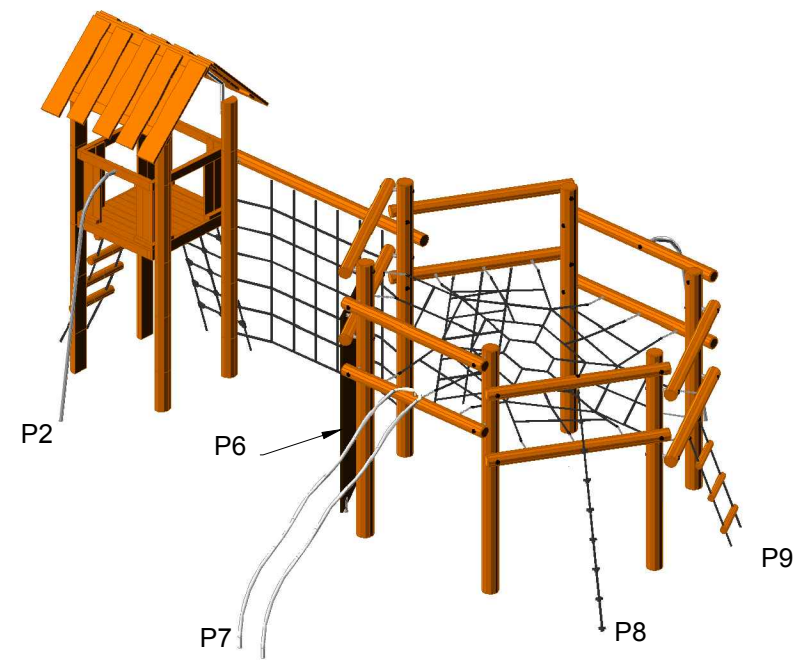
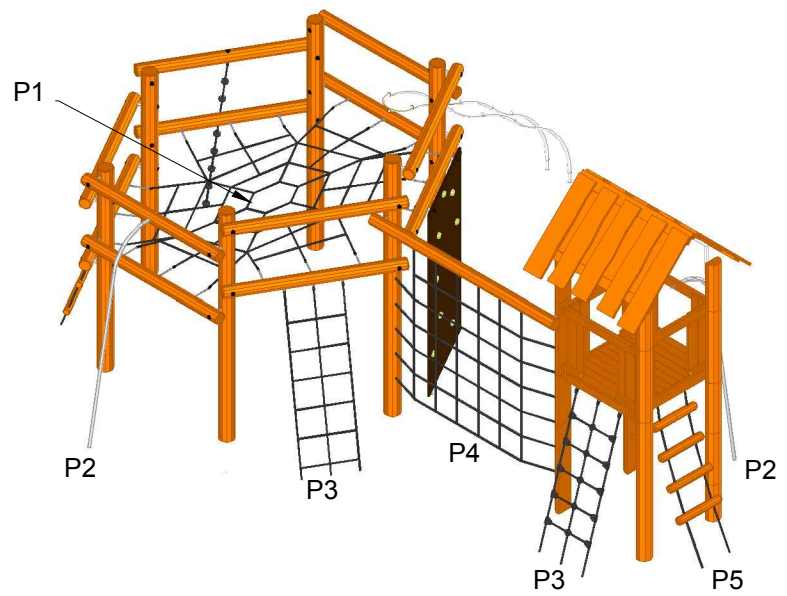

This drawing is the property of NORLEG and pursuant to current legislation may not be copied, transferred to or used by any third party. Should this drawing be used, a fee of 10% of the assumed contract price will be charged.



<b>NORLEG</b> - Mont.	
Sammenbygget system	
LE 20937	
30.06.2015	REV. -

< 2450



≥ EN 1176

Mont.p. nr.

- 2
- 3
- 4
- 9
- 19
- 22
- 23
- 24
- 27
- 28
- 29
- 48
- 49

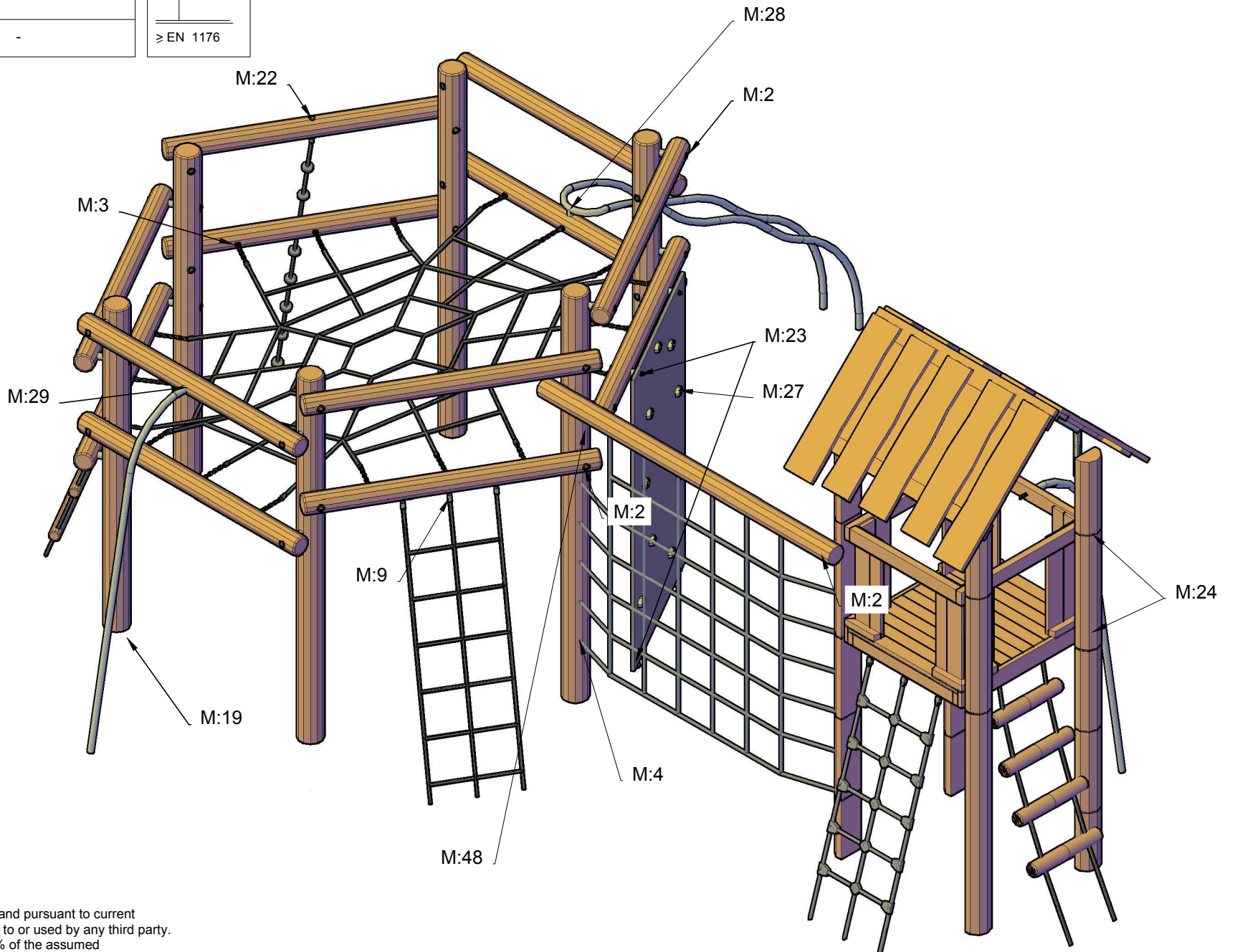

This drawing is the property of NORLEG and pursuant to current legislation may not be copied, transferred to or used by any third party. Should this drawing be used, a fee of 10% of the assumed contract price will be charged.

<b>NORLEG</b> - Mont.	
<b>Sammenbygget system</b>	
LE 20937	
30.06.2015	REV. -

< 2450

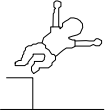

≥ EN 1176

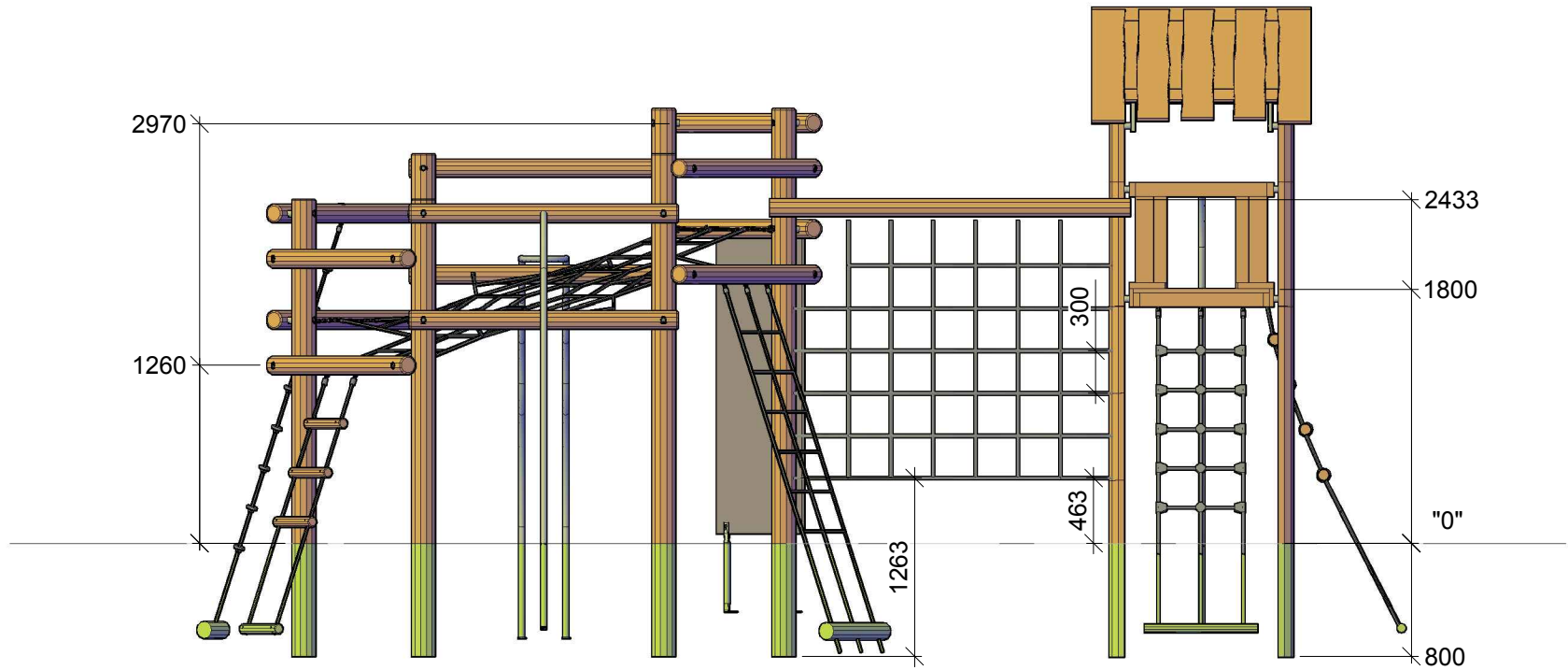

This drawing is the property of NORLEG and pursuant to current legislation may not be copied, transferred to or used by any third party. Should this drawing be used, a fee of 10% of the assumed contract price will be charged.

<b>NORLEG</b> - Mont.	
<b>Sammenbygget system</b>	
LE 20937	
30.06.2015	REV. -

< 2450



≥ EN 1176

Robinia		
Mrk.	QTY	Part.no
1	1	160-180-3870-z
2	1	160-180-3550-z
3	1	160-180-3230-z
4	1	160-180-3230-z
5	1	160-180-3550-z
6	1	160-180-3870-z
7	4	120-140-1900-z

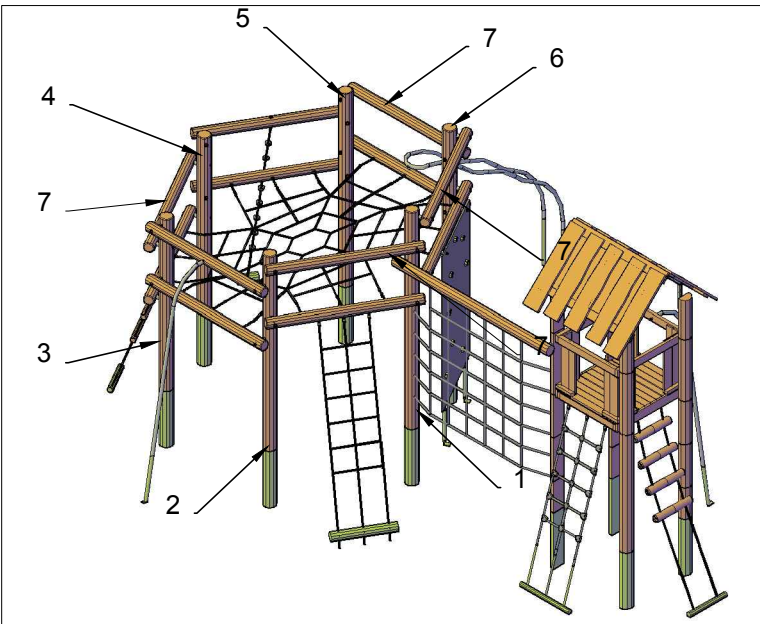

Robinia		
Mrk.	QTY	Part.no
8	2	120-140-1900-z
9	1	120-140-1900-z
10	1	120-140-1900-z
11	1	120-140-1900-z
12	1	120-140-1900-z
13	1	120-140-1900-z
14	1	120-140-1900-z
15	1	120-140-2550-z
16	4	160-180-3900-k

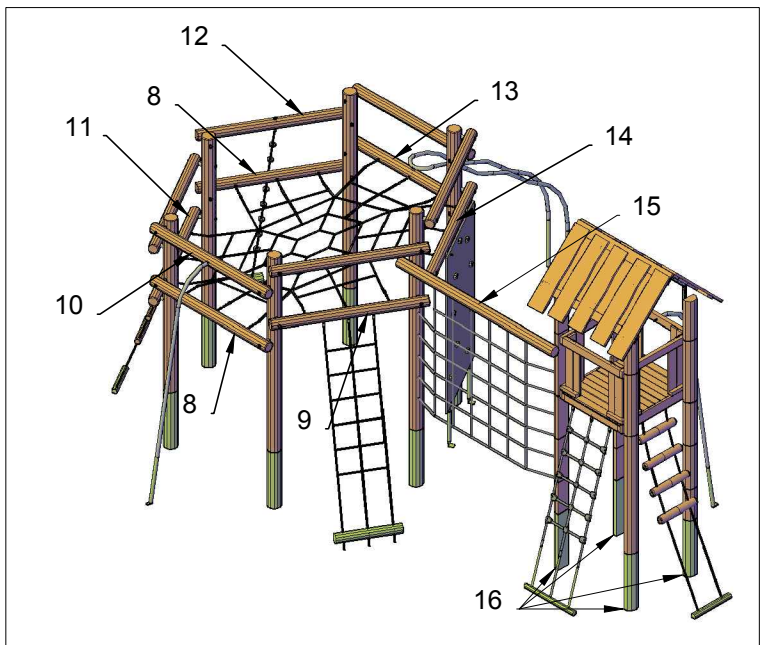



# NORLEG - Produktion

## Sammenbygget system

LE 20937

30.06.2015

REV. -

### Robinia

Mrk.	QTY	Part.no
1	1	160-180-3870-z
2	1	160-180-3550-z
3	1	160-180-3230-z
4	1	160-180-3230-z
5	1	160-180-3550-z
6	1	160-180-3870-z
7	4	120-140-1900-z

k = Kantskåret  
 d = Dobbeltskåret  
 v = Vinkelskåret  
 h = Halvskåret  
 t = k på 3 sider  
 z = Speciel - se detalje

Alle ender over jord affases, min. r3  
 Der monteres nulmærke, "0"  
 Der forbores i stammer iht. M:2 og skabelon

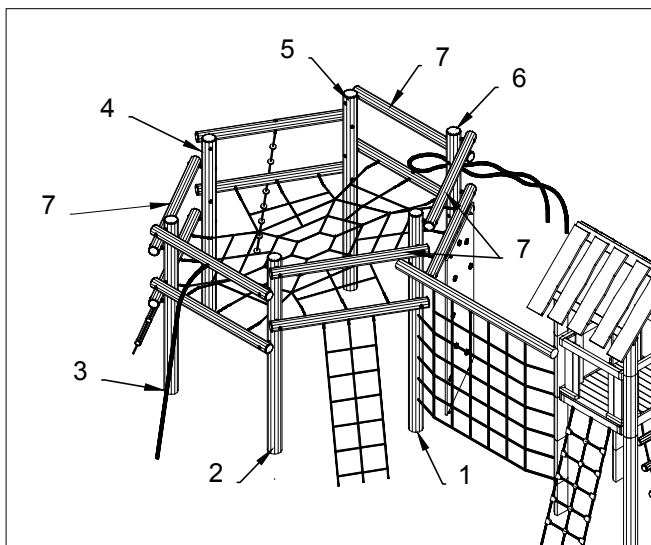

Denne tegning er NORLEG's ejendom, og må ifølge gældende lov ikke kopieres, overlades eller udnyttes af 3. mand. Sker dette, skal det påregnes, at der vil blive opkrævet et honorar på 10% af formodet entreprisesum.

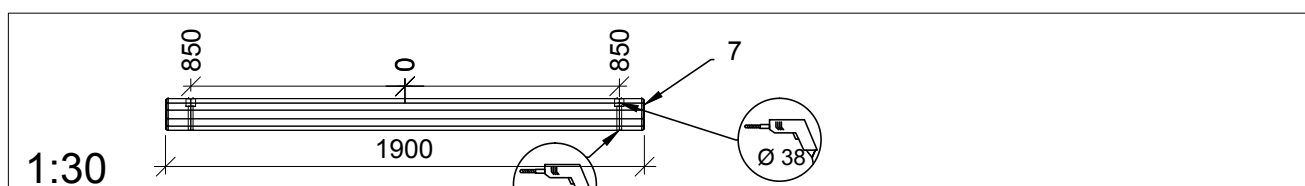
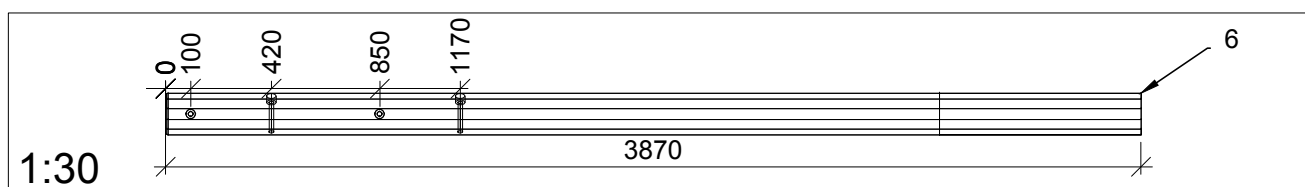
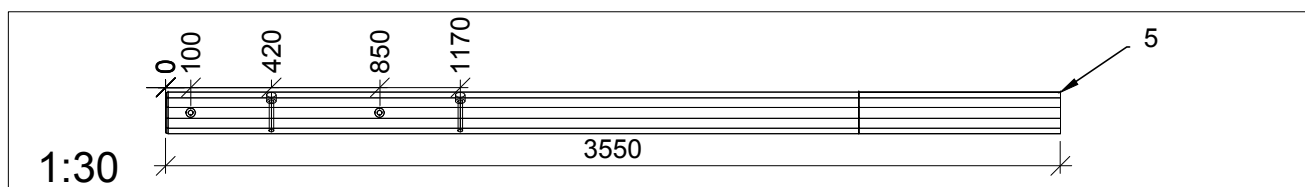
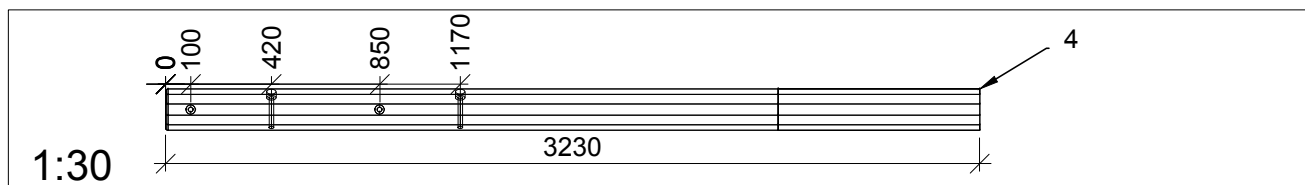
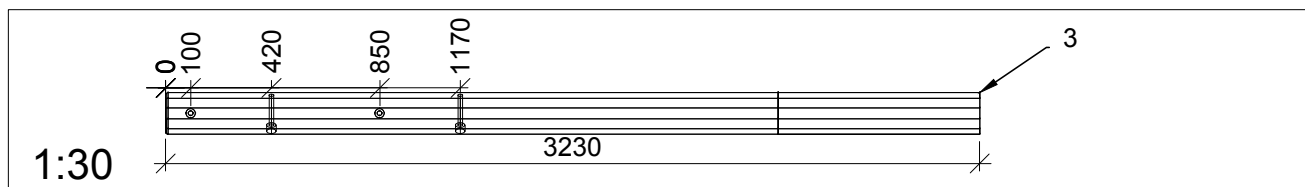
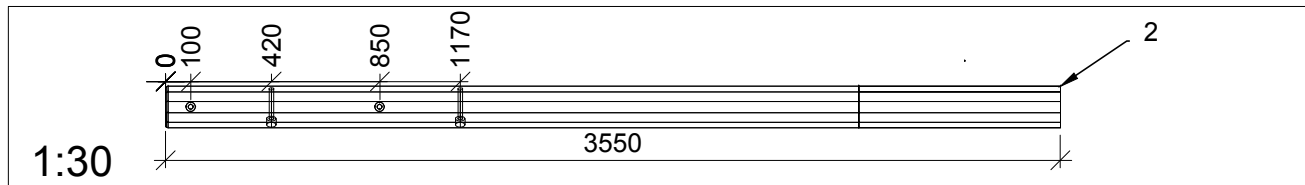
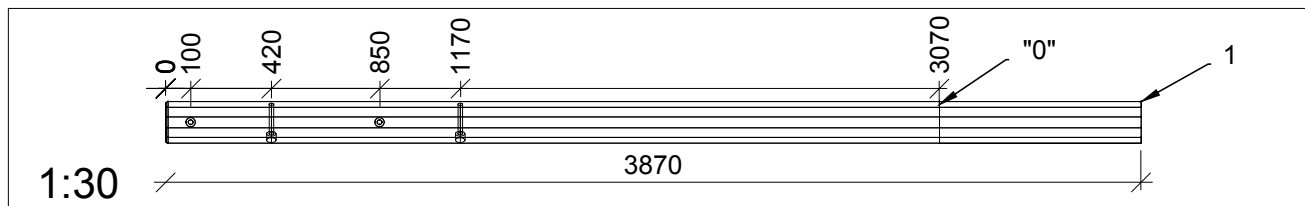

<b>NORLEG - Produktion</b>	
Sammenbygget system	
LE 20937	
30.06.2015	REV. -

Robinia		
Mrk.	QTY	Part.no
8	2	120-140-1900-z
9	1	120-140-1900-z
10	1	120-140-1900-z
11	1	120-140-1900-z
12	1	120-140-1900-z
13	1	120-140-1900-z
14	1	120-140-1900-z

k = Kantskåret  
 d = Dobbeltskåret  
 v = Vinkelskåret  
 h = Halvskåret  
 t = k på 3 sider  
 z = Speciel - se detalje

Alle ender over jord affases, min. r3  
 Der monteres nulmærke, "0"  
 Der forbores i stammer iht. M:2 og skabelon  
 Der monteres øjebolte iht. M:3 og M:9

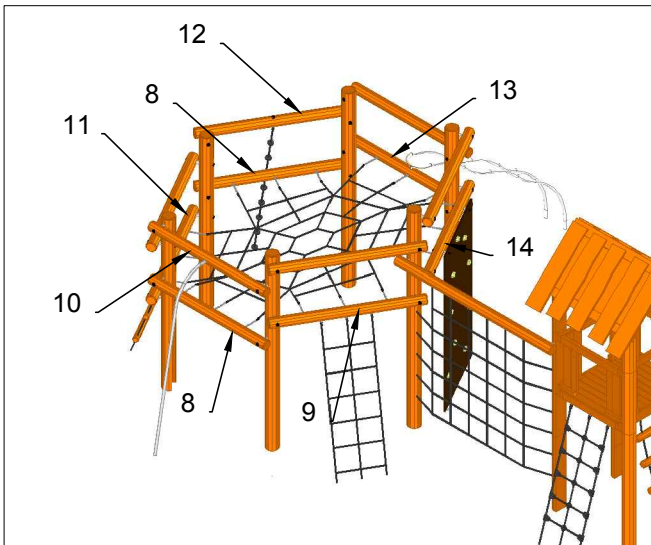

Denne tegning er NORLEG's ejendom, og må ifølge gældende lov ikke kopieres, overlades eller udnyttes af 3. mand. Sker dette, skal det påregnes, at der vil blive opkrævet et honorar på 10% af formodet entreprisum.

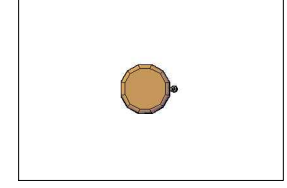
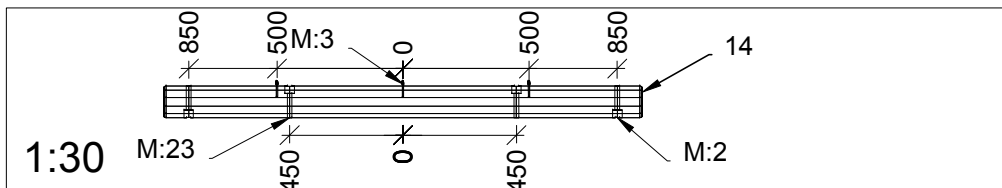
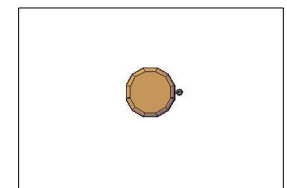
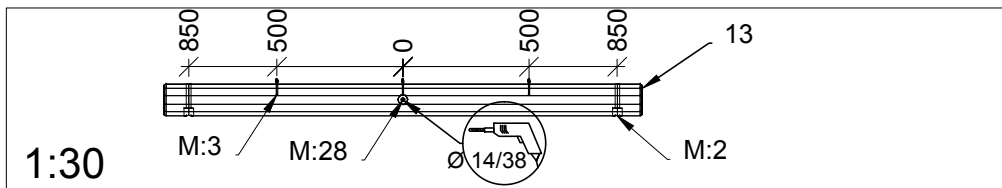
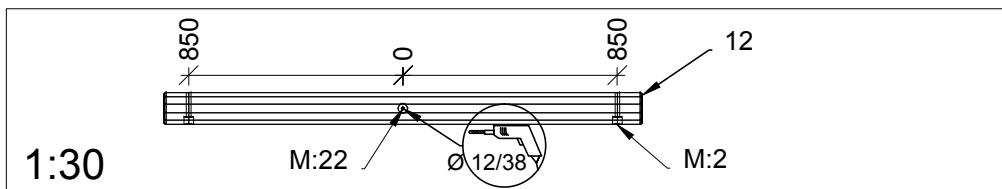
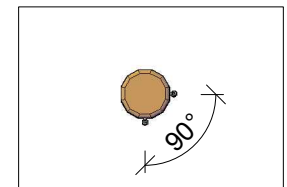
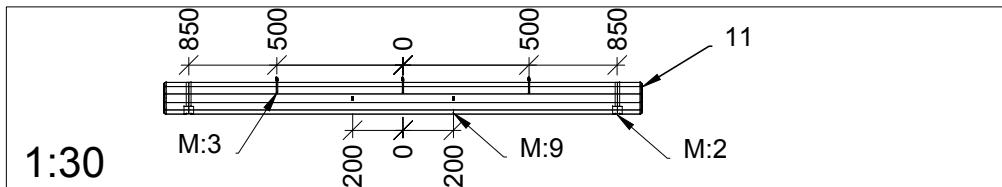
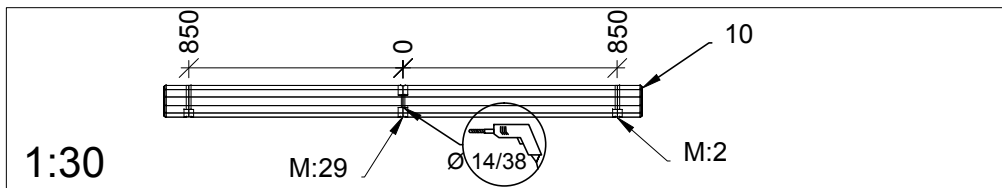
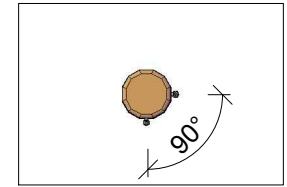
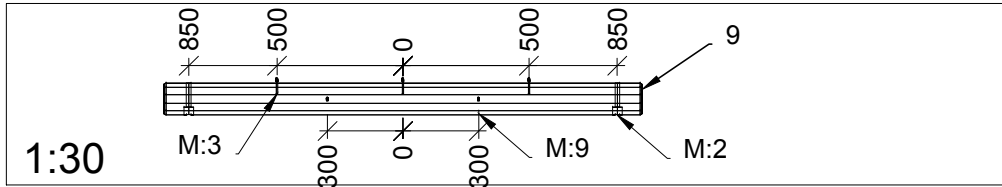
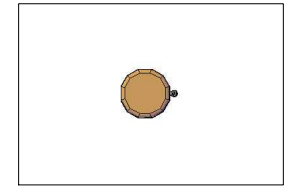
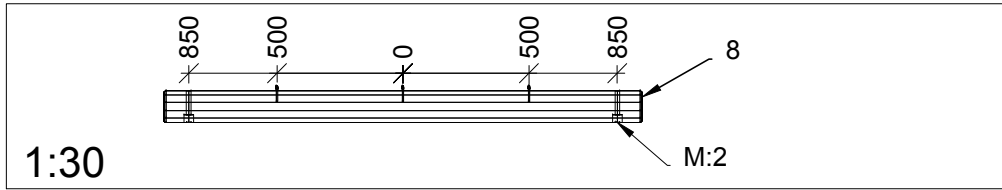

# NORLEG - Produktion

## Sammenbygget system

LE 20937

30.06.2015

REV. -

### Robinia

Mrk.	QTY	Part.no
8	2	120-140-1900-z
9	1	120-140-1900-z
10	1	120-140-1900-z
11	1	120-140-1900-z
12	1	120-140-1900-z
13	1	120-140-1900-z
14	1	120-140-1900-z
15	1	120-140-2550-z
16	4	160-180-3900-k

k = Kantskåret  
d = Dobbeltskåret  
v = Vinkelskåret  
h = Halvskåret  
t = k på 3 sider  
z = Speciel - se detalje

Alle ender over jord affases, min. r3  
Der monteres nulmærke, "0"  
Der forbores i stammer iht. M:2 og skabelon  
Der monteres øjebolte iht. M:3 og M:9

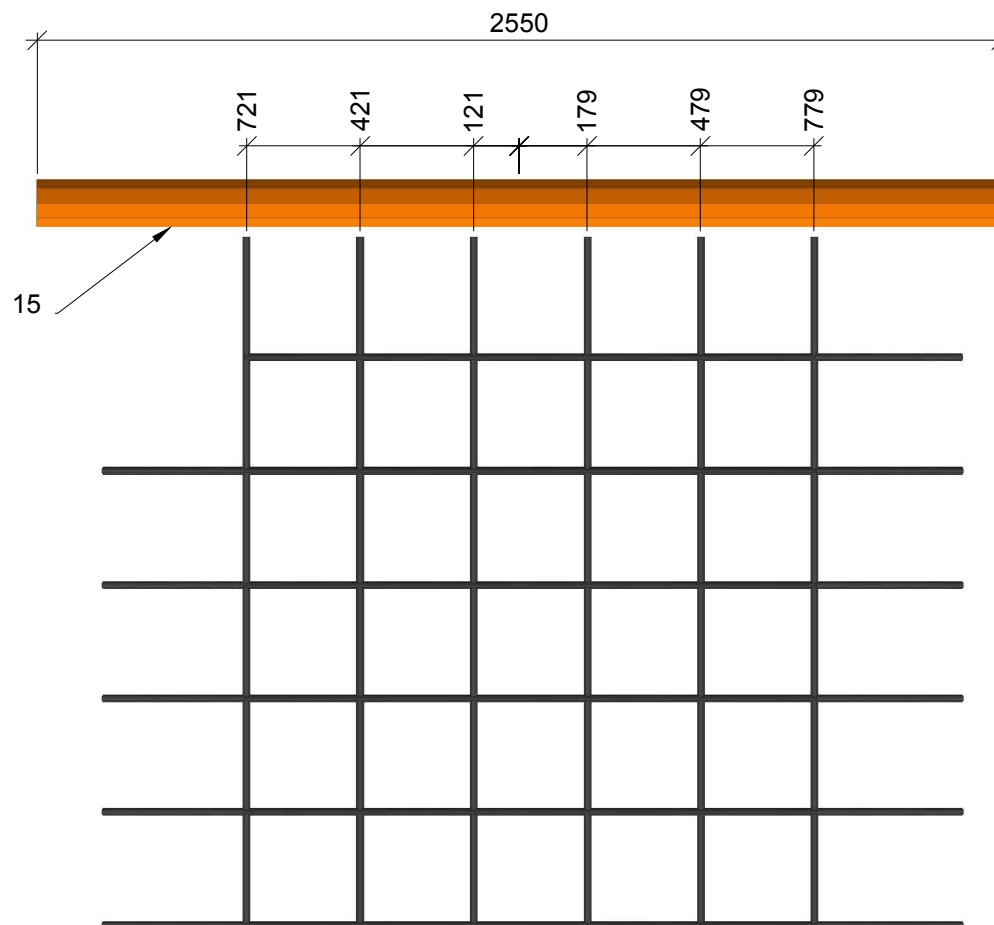

1:20

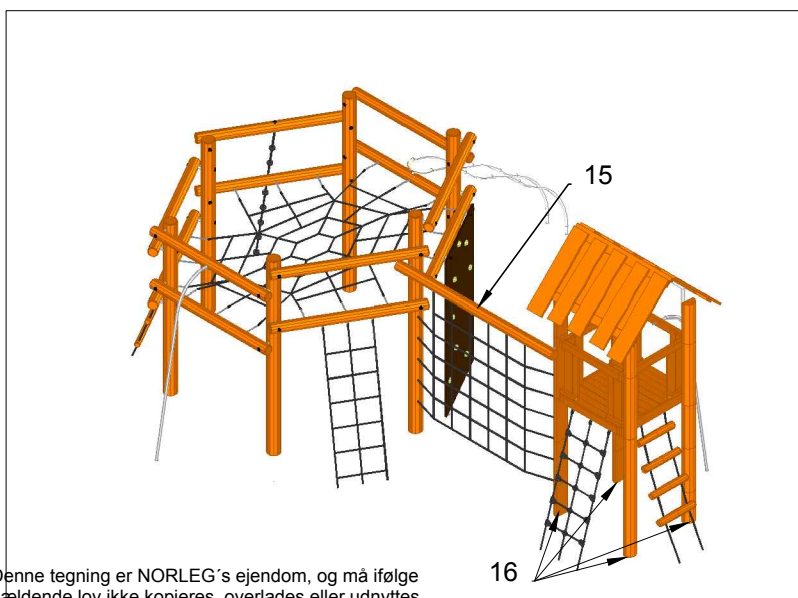

Denne tegning er NORLEG's ejendom, og må ifølge gældende lov ikke kopieres, overlades eller udnyttes af 3. mand. Sker dette, skal det påregnes, at der vil blive opkrævet et honorar på 10% af formodet entreprisensum.