

NORLEG	
Robinia svævebane 40 m	
LE 20295	
07.03.2006	REV.

< 2000

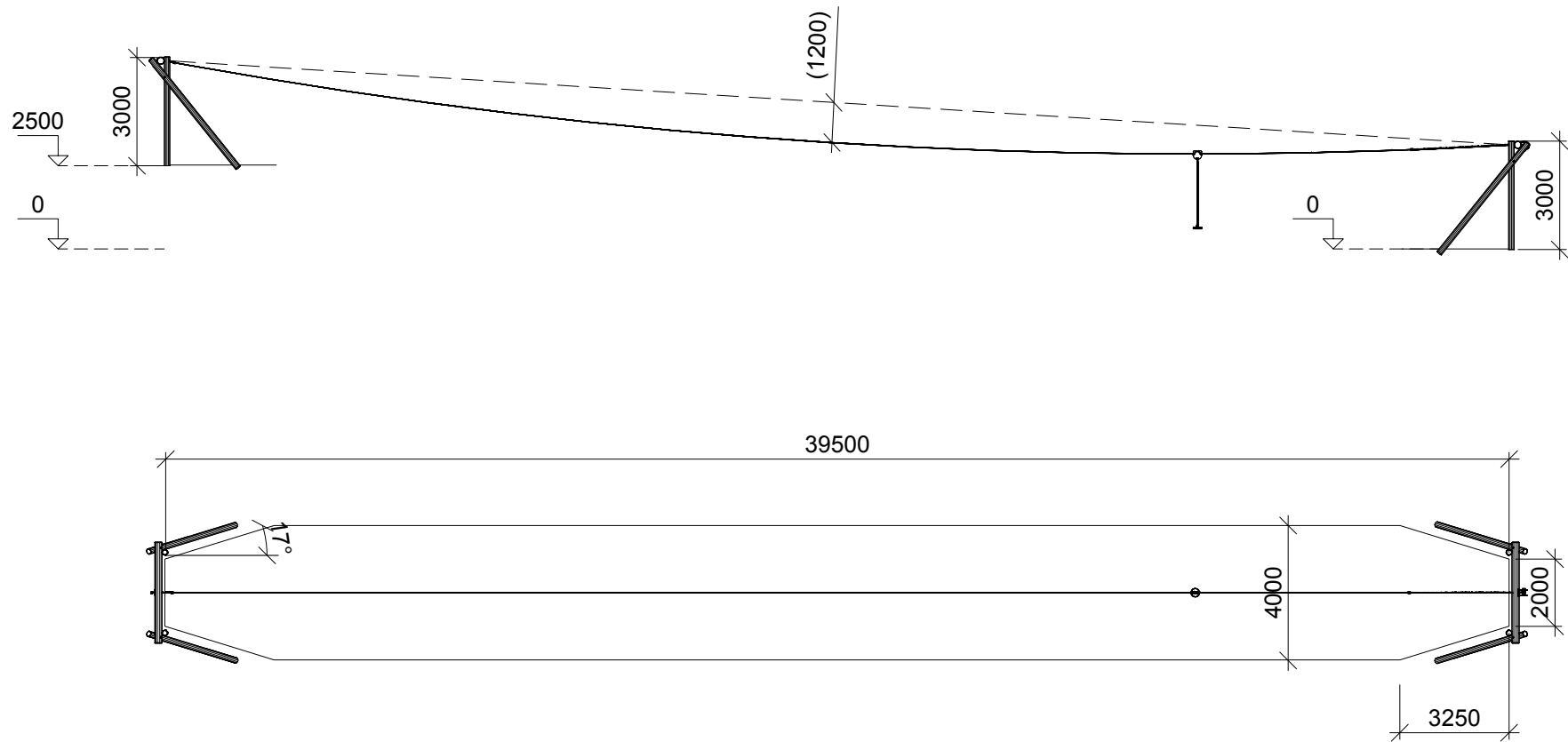

≥ EN 1176



1:200

This drawing is the property of NORLEG and pursuant to current legislation may not be copied, transferred to or used by any third party. Should this drawing be used, a fee of 10% of the assumed contract price will be charged.

NORLEG - 3D	
Robinia svævebane 40 m	
LE 20295	
07.03.2006	REV.

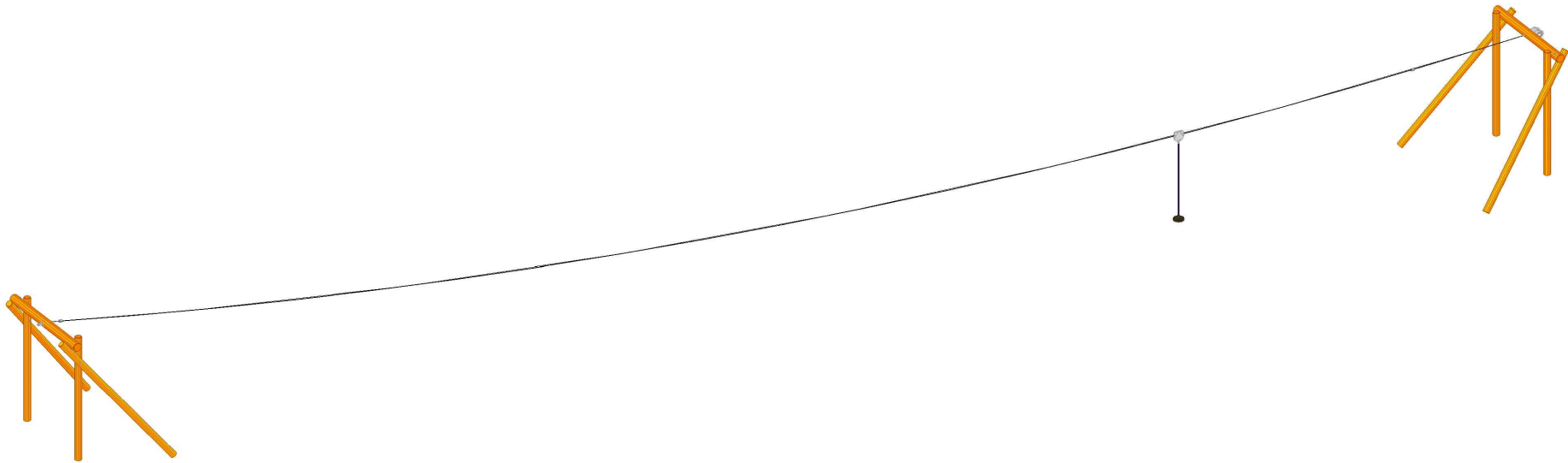

This drawing is the property of NORLEG and pursuant to current legislation may not be copied, transferred to or used by any third party. Should this drawing be used, a fee of 10% of the assumed contract price will be charged.

NORLEG - Mont.	
Robinia svævebane 40 m	
LE 20295	
07.03.2006	REV.

< 2000

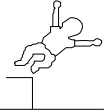

≥ EN 1176

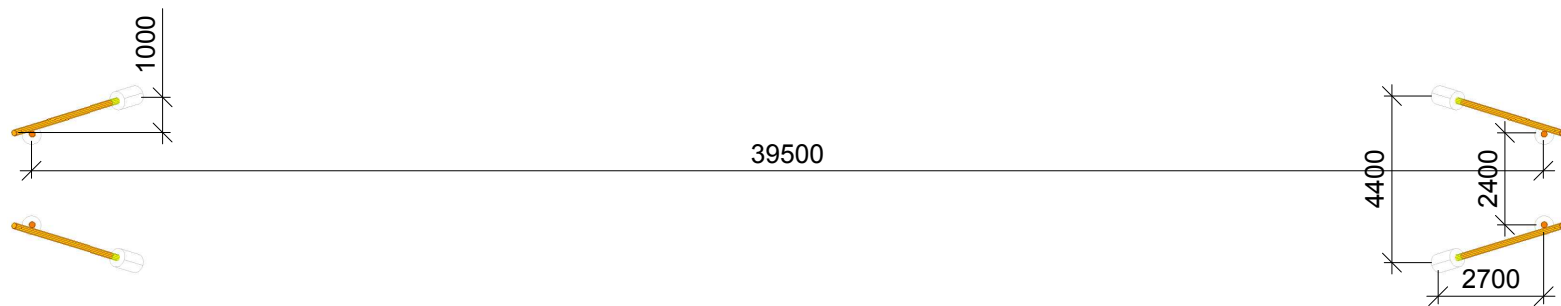

1:200

NORLEG - Mont.	
Robinia svævebane 40 m	
LE 20295	
07.03.2006	REV.

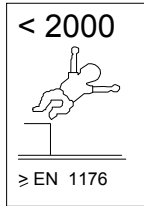

Parts list		
Mrk.	QTY	Part.no
1	2	200-240-3000
2	2	160-180-4000
3	2	160-180-5000
4	2	160-180-5000
5	2	160-180-6000

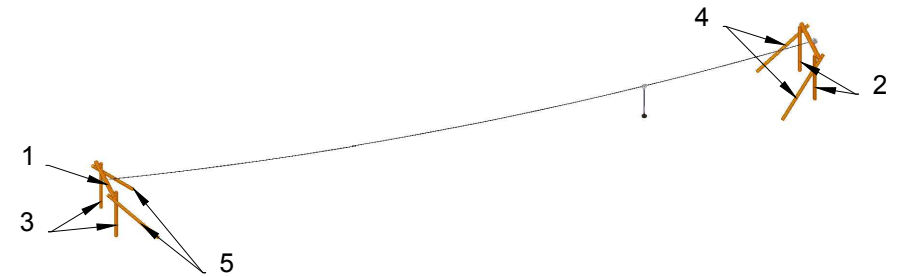

Mont.p. nr.

2C
19
85

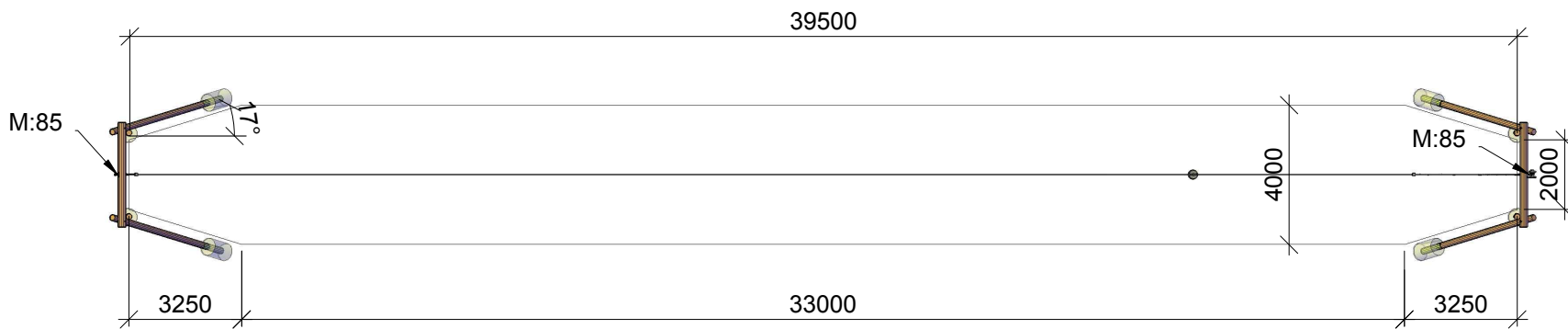
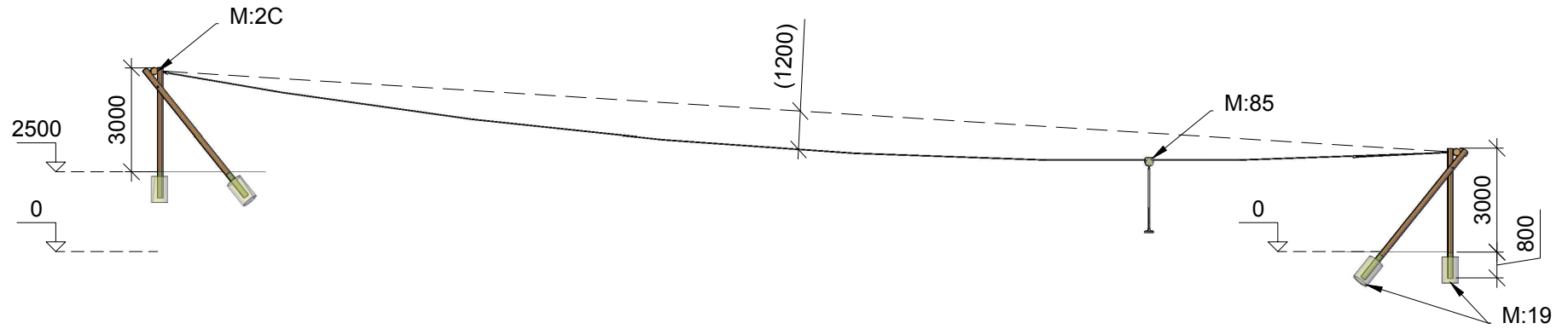

1:200

This drawing is the property of NORLEG and pursuant to current legislation may not be copied, transferred to or used by any third party. Should this drawing be used, a fee of 10% of the assumed contract price will be charged.