

UNLESS OTHERWISE SPECIFIED:
 DIMENSIONS ARE IN MILLIMETERS
 WEIGHT ARE IN KILOGRAMM

PART NUMBER / DWG NO.:

Peter 1

	NAME	SIGNATURE	DATE	REVISION
DRAWN	R.Fedotov		14.05.2015	
APPV'D				

DESCRIPTION:



Tiptaptap OÜ

Tiptaptap OÜ
 Veetorni 9,
 Jüri alevik, Rae vald,
 75301 Harjumaa

MATERIAL:

wood, metal, plastic

A4

WEIGHT:

SCALE: 1:60

SHEET 1 OF 9

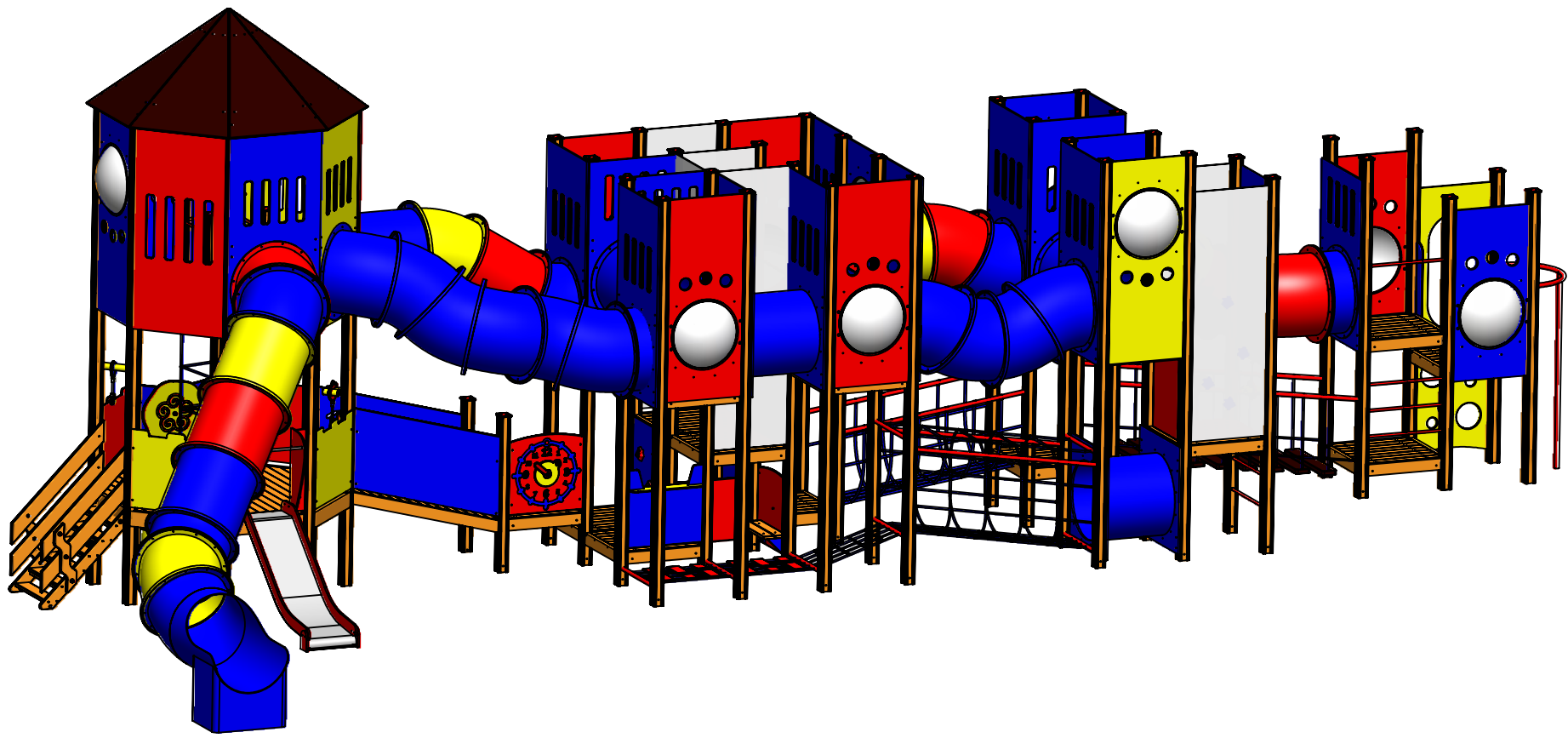

UNLESS OTHERWISE SPECIFIED: DIMENSIONS ARE IN MILLIMETERS WEIGHT ARE IN KILOGRAMM					PART NUMBER / DWG NO.: Peter 1	
	NAME	SIGNATURE	DATE	REVISION	DESCRIPTION:	
DRAWN	R.Fedotov		14.05.2015			
APPV'D						
 Tiptaptap OÜ Tiptaptap OÜ Veetorni 9, Jüri alevik, Rae vald, 75301 Harjumaa					MATERIAL:	wood, metal, plastic
					WEIGHT:	

1

2

3

4

5

6

A

A

B

B

C

C

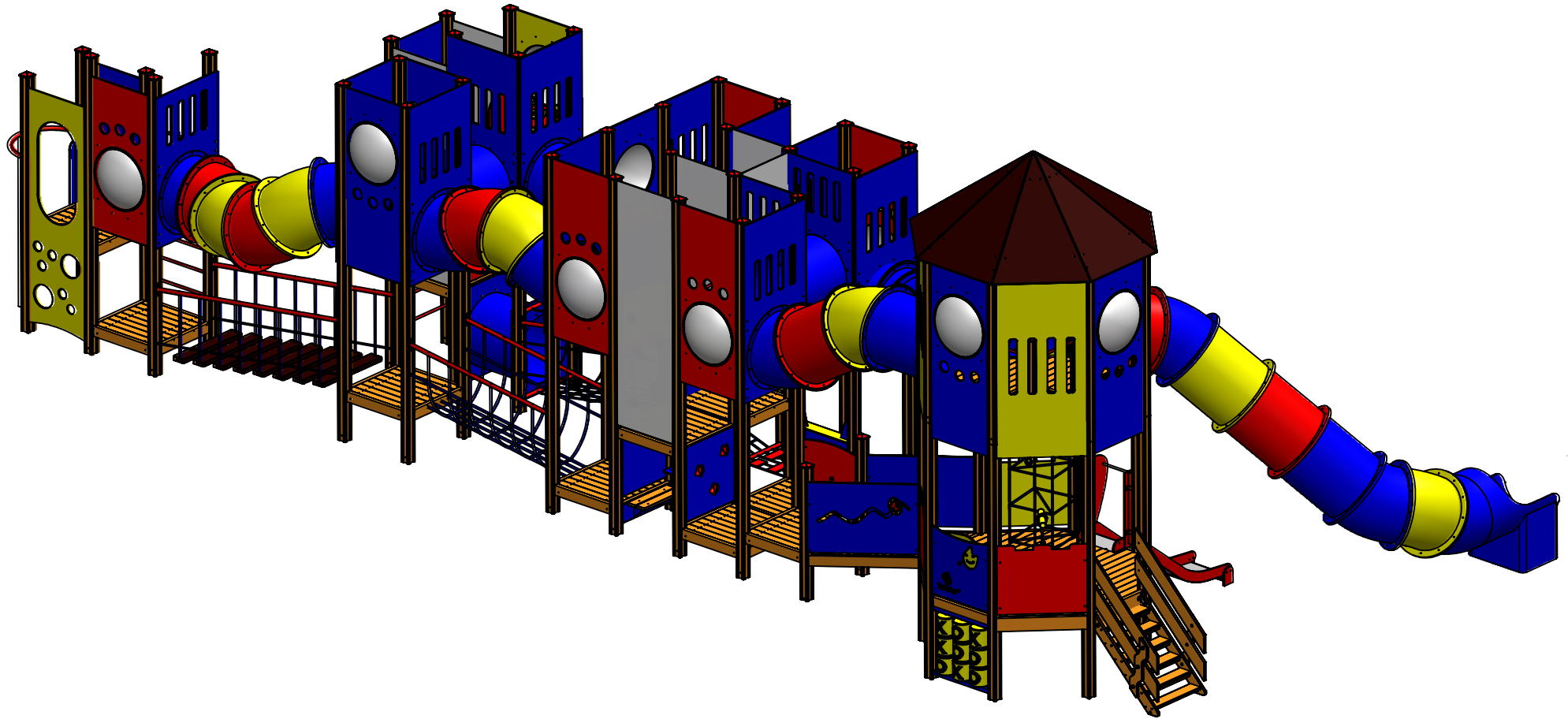

D

UNLESS OTHERWISE SPECIFIED:
DIMENSIONS ARE IN MILLIMETERS
WEIGHT ARE IN KILOGRAMM

PART NUMBER / DWG NO.:

Peter 1

	NAME	SIGNATURE	DATE	REVISION
DRAWN	R.Fedotov		14.05.2015	
APPV'D				

DESCRIPTION:



Tiptaptap OÜ

Tiptaptap OÜ
Veetorni 9,
Jüri alevik, Rae vald,
75301 Harjumaa

MATERIAL:

wood, metal, plastic

A4

WEIGHT:

SCALE: 1:60

SHEET 3 OF 9

1

2

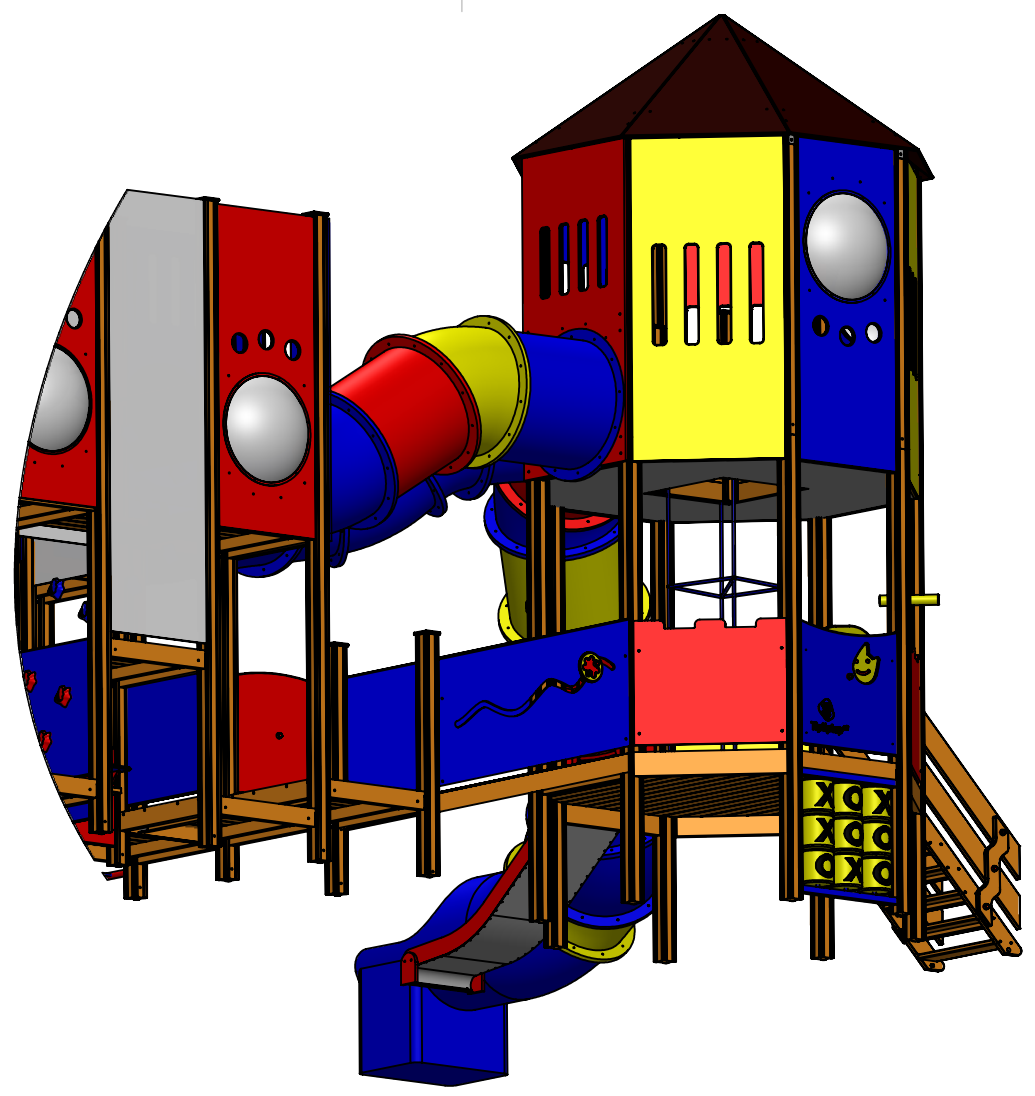

UNLESS OTHERWISE SPECIFIED: DIMENSIONS ARE IN MILLIMETERS WEIGHT ARE IN KILOGRAMM					PART NUMBER / DWG NO.: Peter 1	
	NAME	SIGNATURE	DATE	REVISION	DESCRIPTION:	
DRAWN	R.Fedotov		14.05.2015			
APPV'D						
 Tiptiptap OÜ Tiptiptap OÜ Veetorni 9, Jüri alevik, Rae vald, 75301 Harjumaa					MATERIAL:	wood, metal, plastic
					WEIGHT:	SCALE: 1:45
					SHEET 4 OF 9	

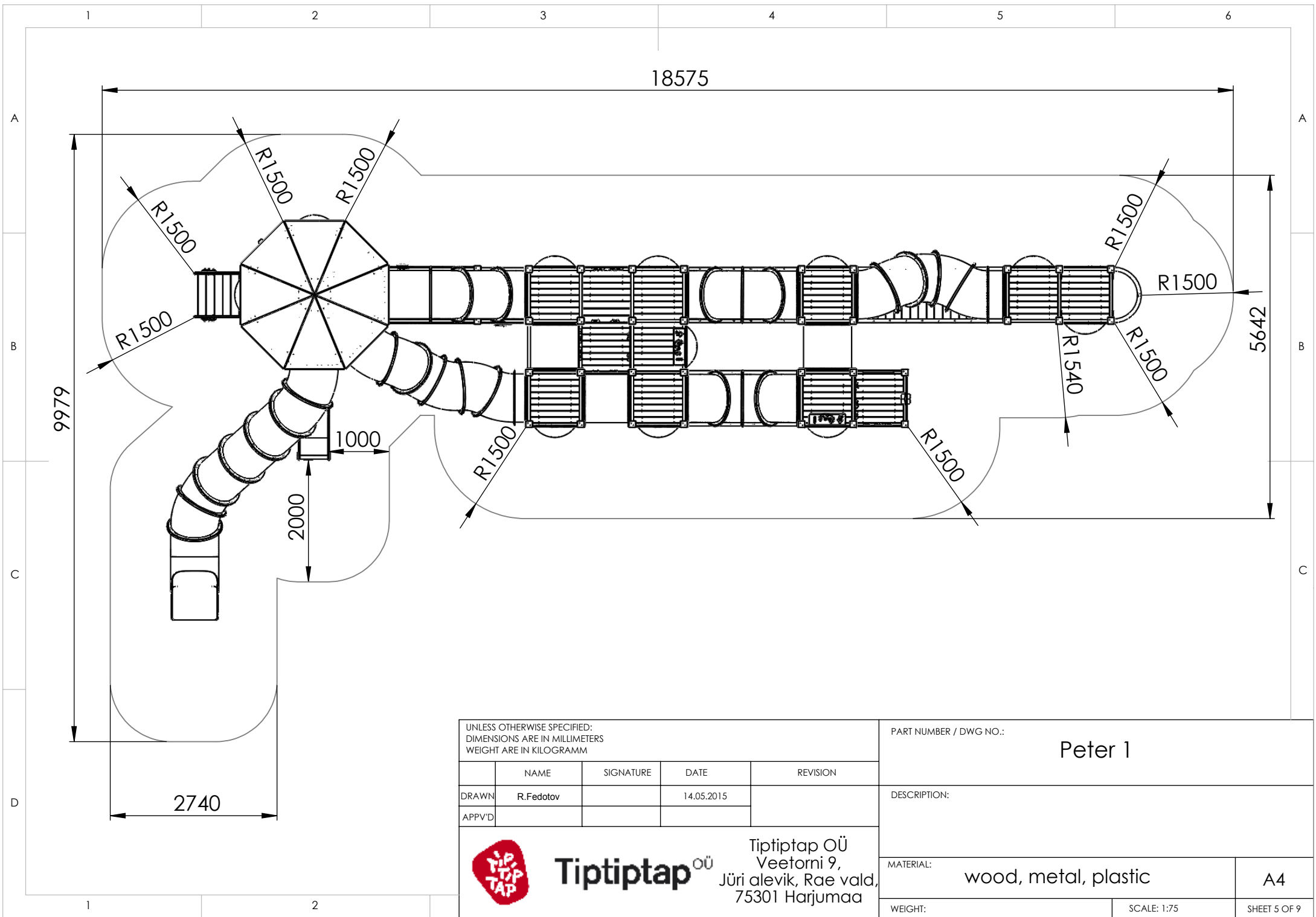

UNLESS OTHERWISE SPECIFIED:
 DIMENSIONS ARE IN MILLIMETERS
 WEIGHT ARE IN KILOGRAMM

PART NUMBER / DWG NO.: **Peter 1**

	NAME	SIGNATURE	DATE	REVISION
DRAWN	R.Fedotov		14.05.2015	
APPV'D				

DESCRIPTION:



Tiptiptap OÜ
 Tiptiptap OÜ
 Veetorni 9,
 Jüri alevik, Rae vald,
 75301 Harjumaa

MATERIAL:	wood, metal, plastic	A4
WEIGHT:	SCALE: 1:75	SHEET 5 OF 9

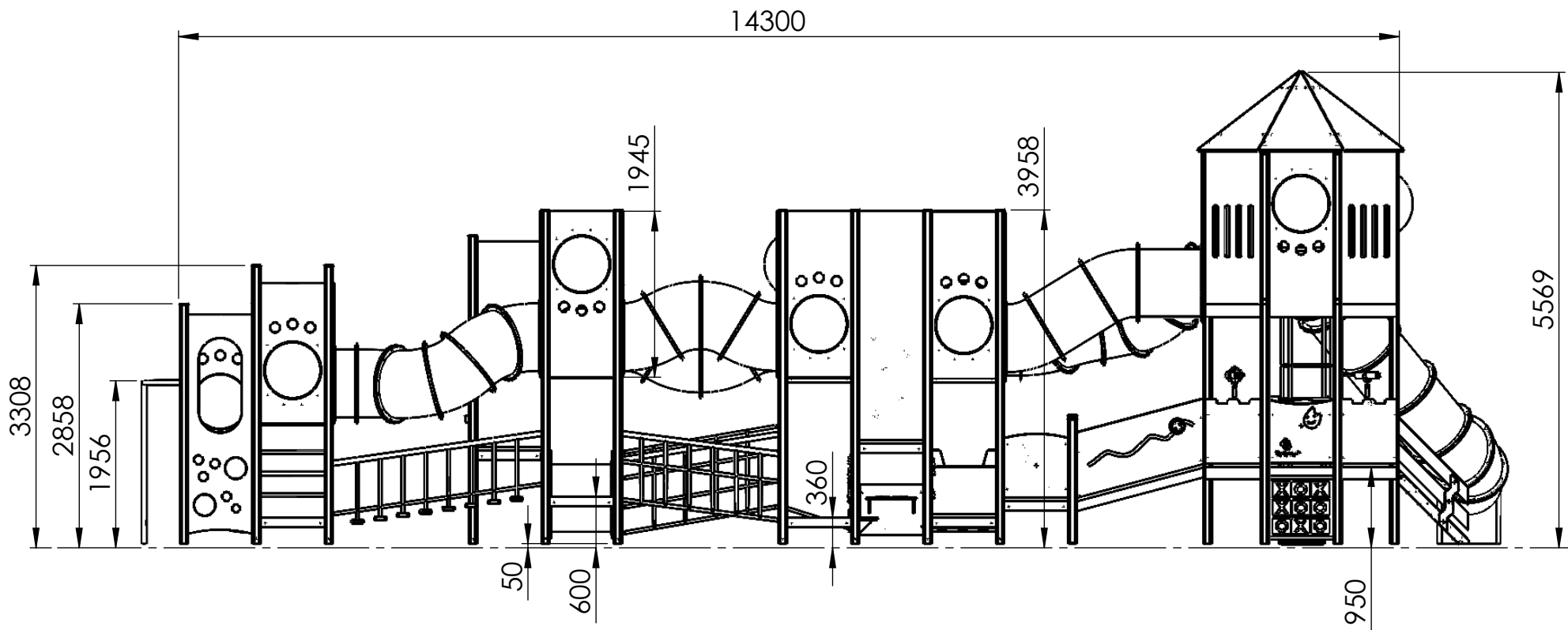

UNLESS OTHERWISE SPECIFIED:
 DIMENSIONS ARE IN MILLIMETERS
 WEIGHT ARE IN KILOGRAMM

PART NUMBER / DWG NO.: Peter 1

	NAME	SIGNATURE	DATE	REVISION
DRAWN	R.Fedotov		14.05.2015	
APPV'D				

DESCRIPTION:

Tiptaptap OÜ
 Veetorni 9,
 Jüri alevik, Rae vald,
 75301 Harjumaa

MATERIAL:	wood, metal, plastic	A4
WEIGHT:		SCALE: 1:70
		SHEET 6 OF 9

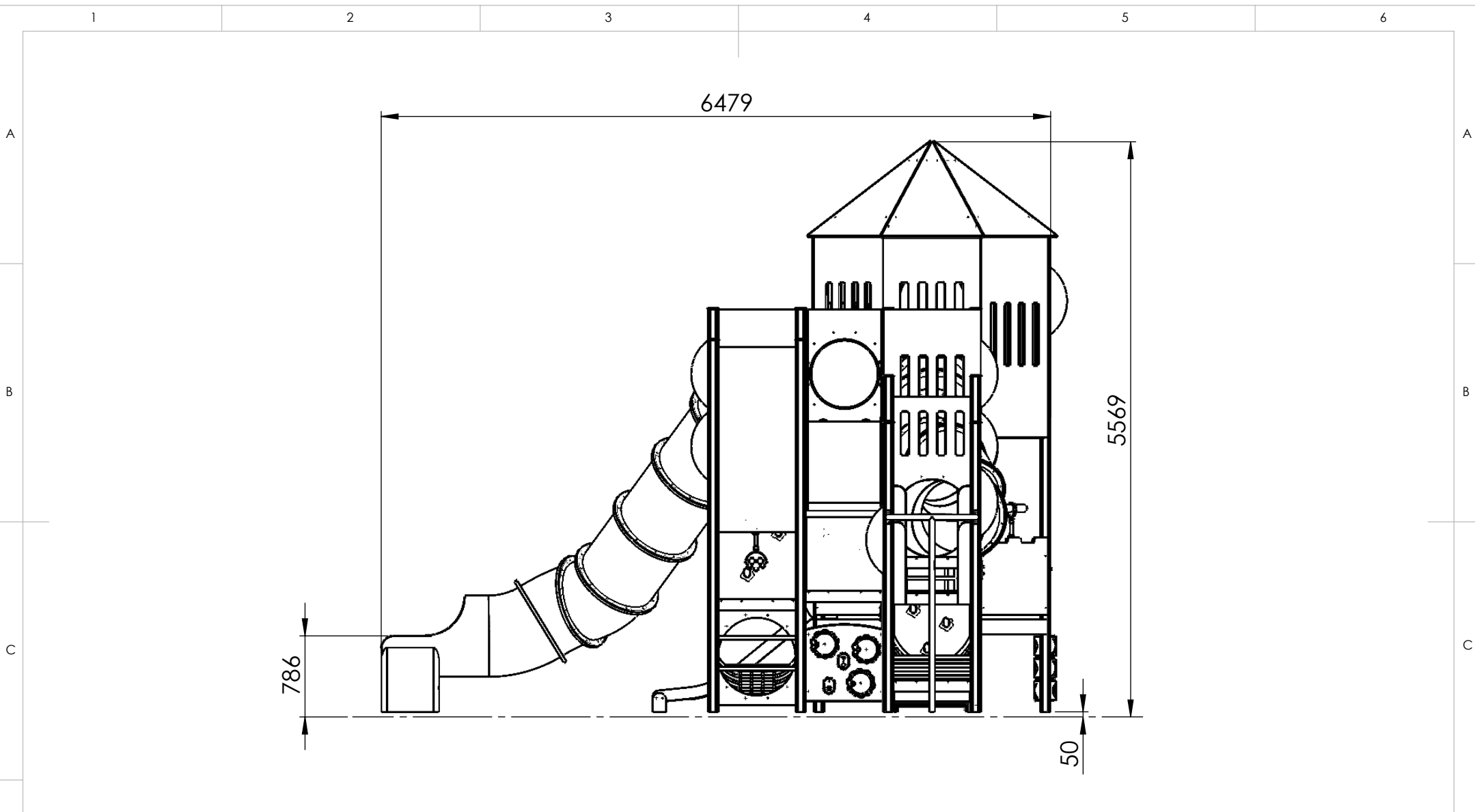

UNLESS OTHERWISE SPECIFIED:
 DIMENSIONS ARE IN MILLIMETERS
 WEIGHT ARE IN KILOGRAMM

PART NUMBER / DWG NO.: Peter 1

	NAME	SIGNATURE	DATE	REVISION
DRAWN	R.Fedotov		14.05.2015	
APPV'D				

DESCRIPTION:



Tiptaptap OÜ
 Veetorni 9,
 Jüri alevik, Rae vald,
 75301 Harjumaa

MATERIAL:	wood, metal, plastic	A4
WEIGHT:		SCALE: 1:50
		SHEET 7 OF 9

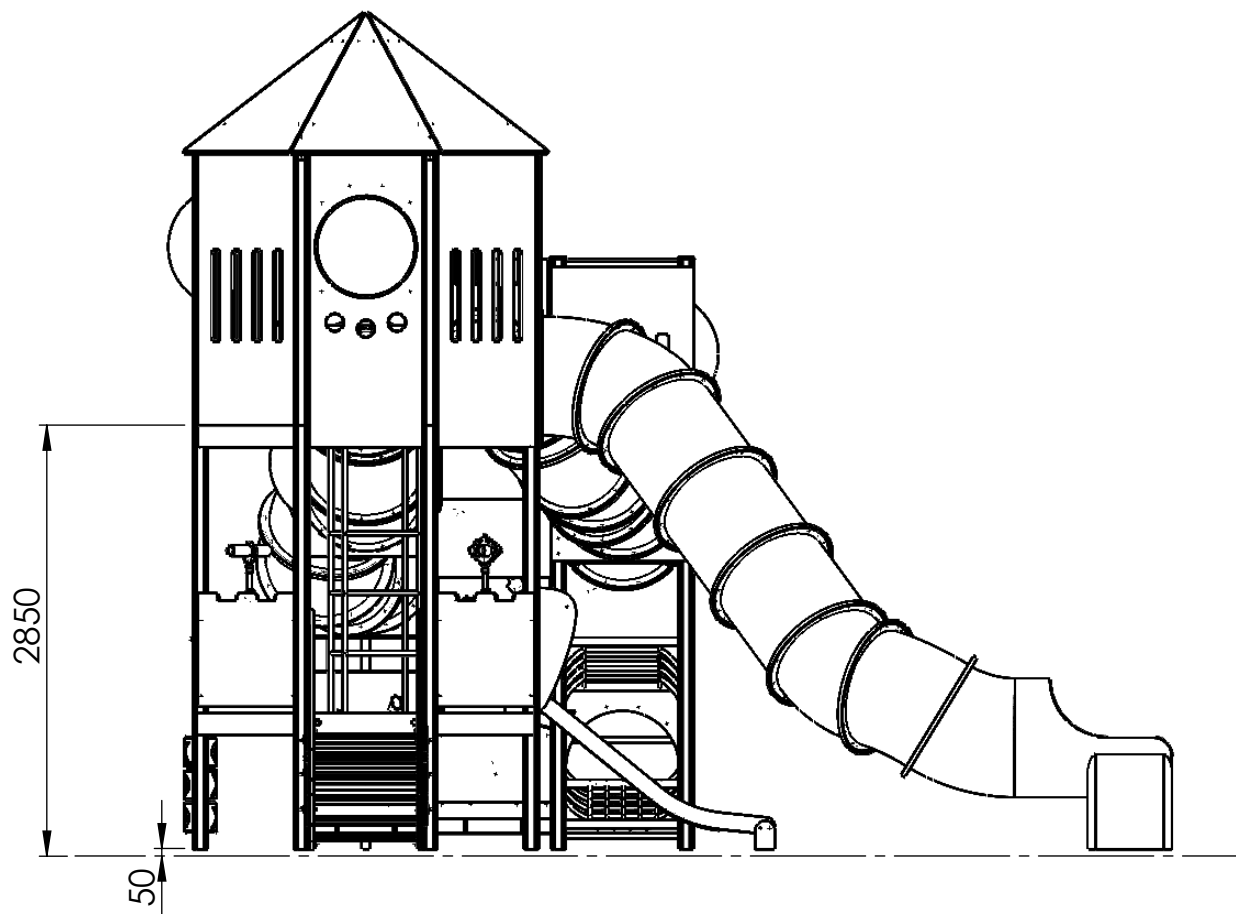

UNLESS OTHERWISE SPECIFIED:
DIMENSIONS ARE IN MILLIMETERS
WEIGHT ARE IN KILOGRAMM

PART NUMBER / DWG NO.:

Peter 1

	NAME	SIGNATURE	DATE	REVISION
DRAWN	R.Fedotov		14.05.2015	
APPV'D				

DESCRIPTION:



Tiptaptap OÜ

Tiptaptap OÜ
Veetorni 9,
Jüri alevik, Rae vald,
75301 Harjumaa

MATERIAL:

wood, metal, plastic

A4

WEIGHT:

SCALE: 1:50

SHEET 8 OF 9

1 2 3 4 5 6

A

A

B

B

C

C

D

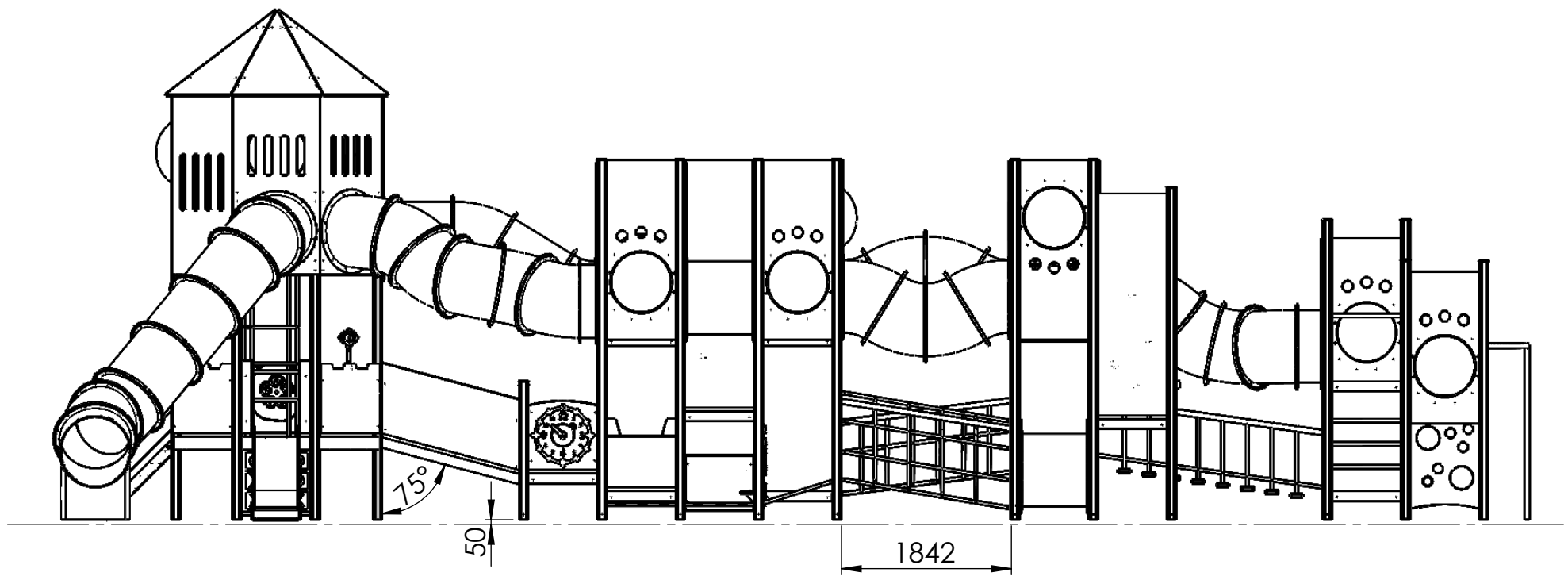

UNLESS OTHERWISE SPECIFIED:
 DIMENSIONS ARE IN MILLIMETERS
 WEIGHT ARE IN KILOGRAMM

PART NUMBER / DWG NO.: Peter 1

	NAME	SIGNATURE	DATE	REVISION
DRAWN	R.Fedotov		14.05.2015	
APPV'D				

DESCRIPTION:



Tiptaptap OÜ
 Veetorni 9,
 Jüri alevik, Rae vald,
 75301 Harjumaa

MATERIAL: wood, metal, plastic

A4

WEIGHT: SCALE: 1:65 SHEET 9 OF 9

1 2