

A

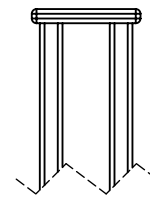

B

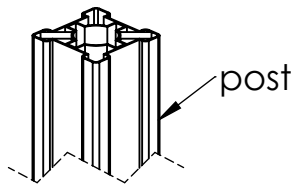
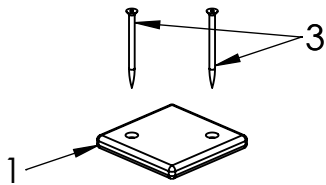
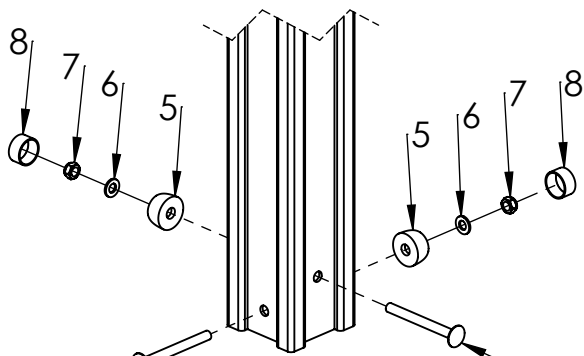

ground

concrete

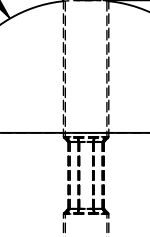
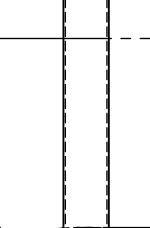
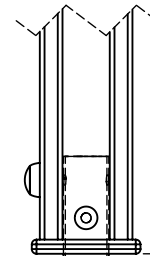

C

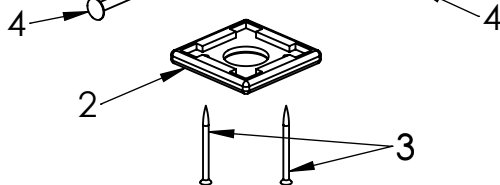

D

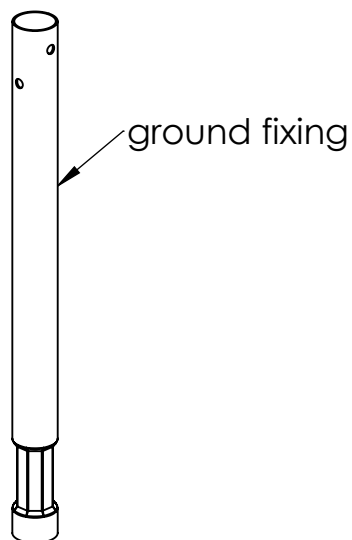

E

ITEM NO.	PART NUMBER
1	plastic cap 115x115
2	plastic cap 115x115 with hole
3	woodscrew 6 x 90
4	bolt DIN603 M10x100
5	nut cover M12
6	washer M10
7	nut DIN985 M10
8	nut cover cap M12

UNLESS OTHERWISE SPECIFIED:
DIMENSIONS ARE IN MILLIMETERS
WEIGHT ARE IN KILOGRAMM

PART NUMBER / DWG NO.:

	NAME	SIGNATURE	DATE	REVISION
DRAWN	M.Rebase		27.06.2014	
APPV'D				

DESCRIPTION:

connecting metal ground fixing to post

MATERIAL:

wood, metal, plastic

A4

WEIGHT:

SCALE: 1:8

SHEET 1 OF 1



Tiptiptap OÜ

Tiptiptap OÜ
Veetorni 9,
Jüri alevik, Rae vald,
75301 Harjumaa